

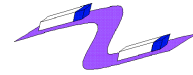

the Quality of Voice over IP



- is it there

- The Goal: Introduction to the quality issues of VoIP.
- Questions to be answered:
 - What are the characteristics of the quality of VoIP?
 - What are the loss, delay and delay variance characteristics of VoIP in an IP switching environment?
 - How much better is the quality of VoIP over IP switching than IP forwarding?
 - What is the error of delay variance estimators designed for best-effort Internet in a campus IP-switching network/IP forwarding network/Ethernet?



Voice over IP

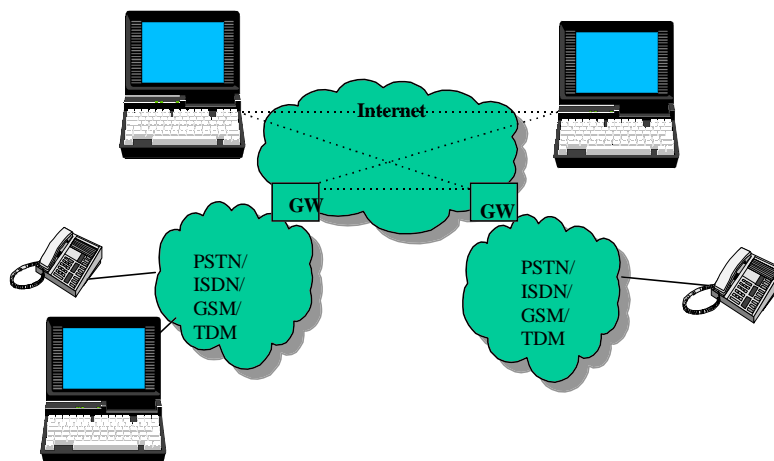
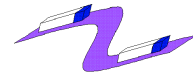



Voice over IP

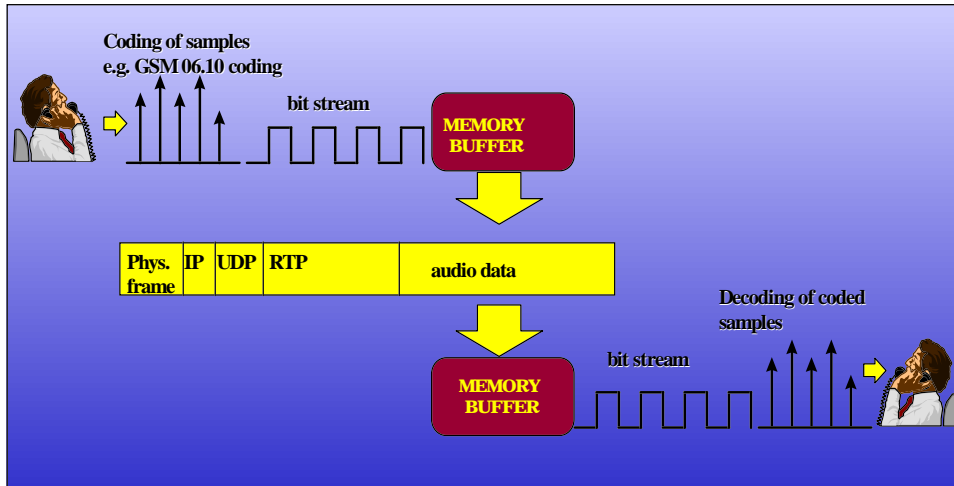
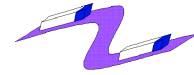

ISO/IEC

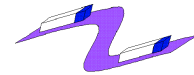

- Quality of under three concepts:
 - The characteristics of QoS
 - Management of QoS
 - Agreements of QoS
- The characteristics of QoS are quantities:
 - throughput, processing delay, network end-to-end delay, delay variance, error rate, packet loss rate



synchronization

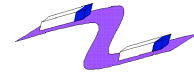

- adjusting the playout time
- Using RTP-sender timestamps:
 - $p_k^i = t_k^i + \text{fixed delay estimate} + \text{variable delay estimate}$
- RTP: Interarrival jitter the mean deviation of the difference in packet spacing at the receiver compared to the sender for a pair of packets
- Difference in packet spacing:
 - $D(k^i, k^j) = (a_k^j - a_k^i) - (t_k^j - t_k^i)$
- various algorithms exist for estimating Jitter from 'D'



some theory

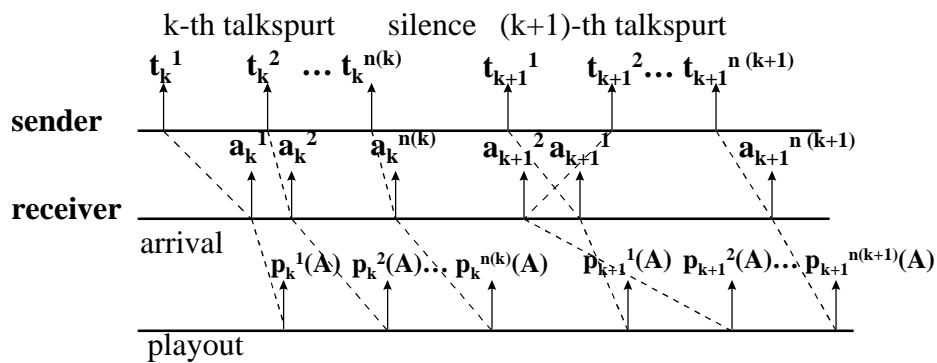
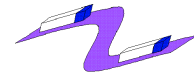

- t_k^i : sender timestamp of i-th packet in k-th talkspurt
- a_k^i : receiver timestamp of i-th packet in k-th talkspurt
- p_k^i : the playout time of i-th packet in k-th talkspurt



IP-puhe ethernetissä

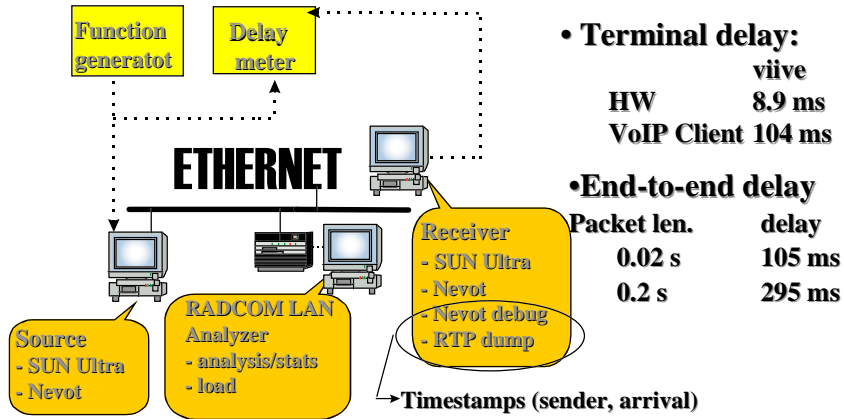
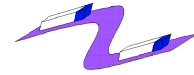

VoIP over IPS



- End to end delay

IP s&f	116 ms
IP kytkentä	114 ms
- Network delay (ping)

for both	1-2 ms
----------	--------

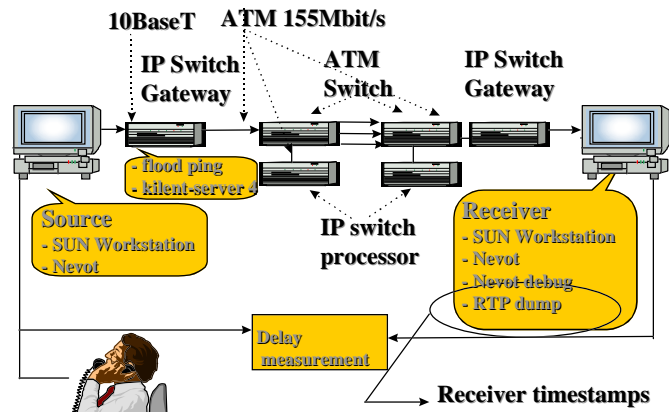



End-to-End Delays PC with Netmeeting

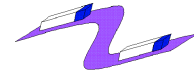

- Setup
 - Using Microsoft Netmeeting, Windows 95
 - Newest DirectX version 5.0 (speeds up coding and decoding)
 - Sounblaster 16 plug&pray
 - **Pentium 133 to Pentium 100 MHz**
- **HW delay inside PC mike to speaker:**
5,4 ms
- End to End delay over LANE
 - 170 - 190 ms
 - **ping delay 1 ms**



IPS with no load



- s&f

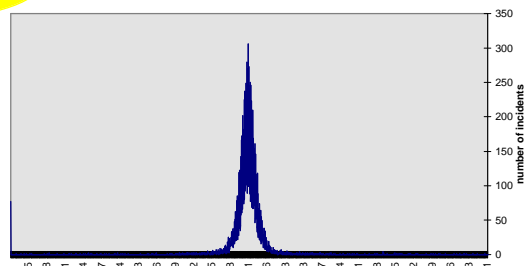

- IPS

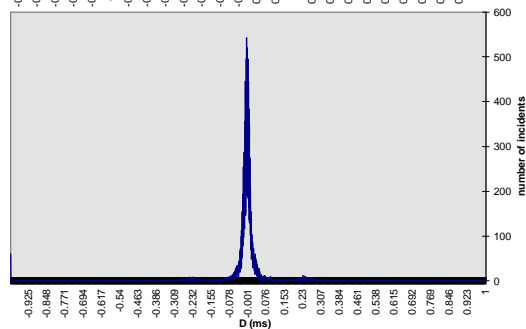



Ethernet - load w. large packets

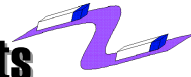

- Load
 - 590 - 630 frames/s
 - 6.8 - 7.2 Mbit/s

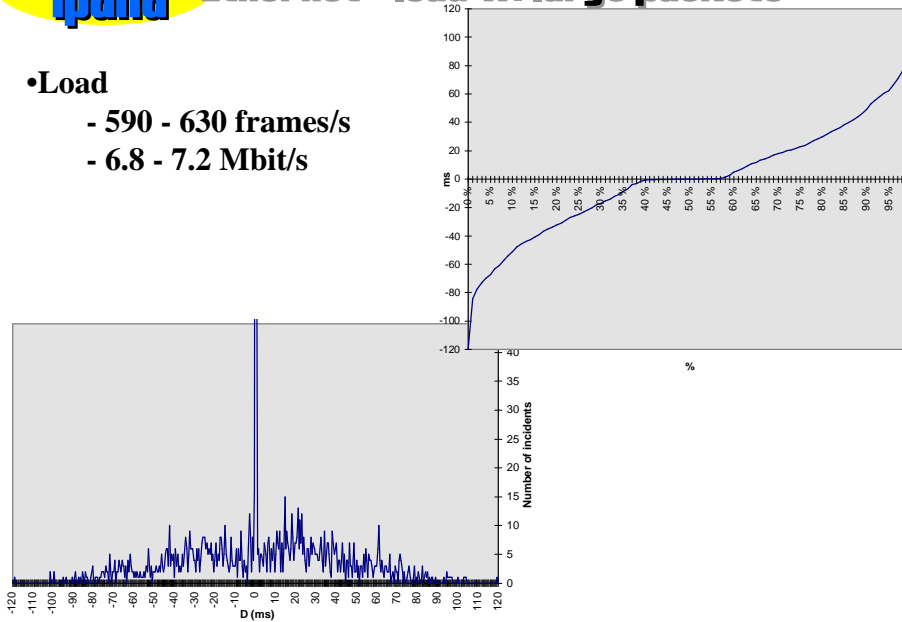

IP switching loaded with flood ping

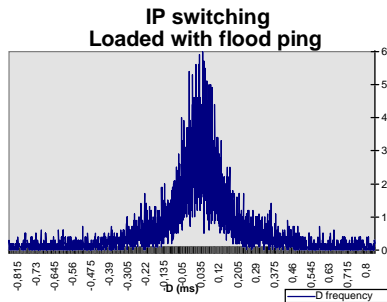
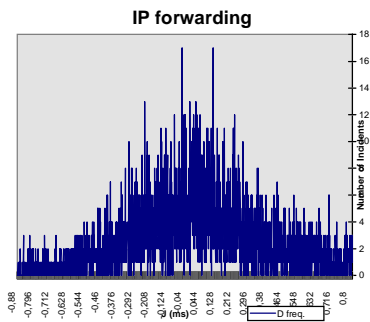
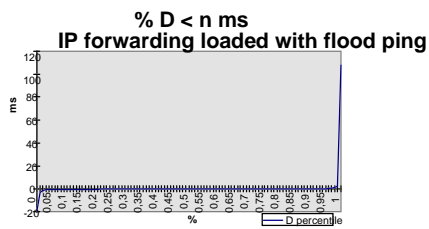

- ping load 2x40 Mbit/s
- ran from edge routers
- large packets



ip switching TCP/IP load (2) ...frequencies

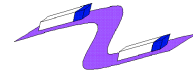

- Load with a perl-script:
 - ran on edge routers
 - sends 1500 byte TCP/IP packets

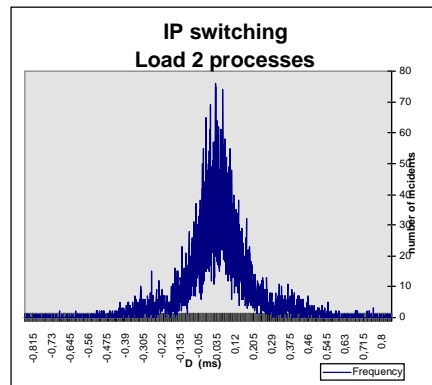
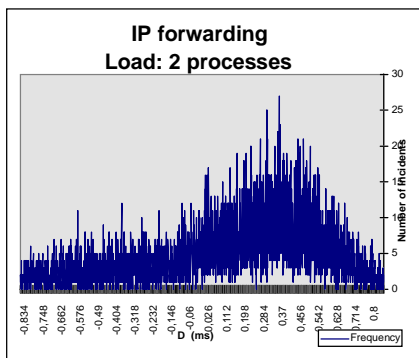

ip switching TCP/IP load (2) network load in measurement

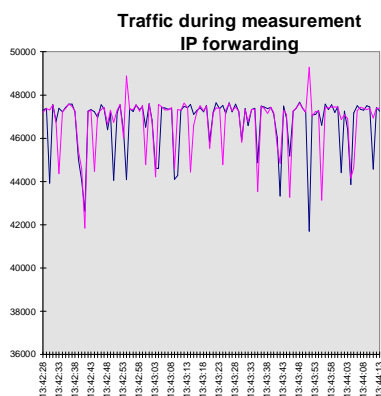
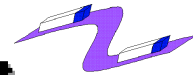

- Mean 46729 Kbit/s
- Minimum 41709 Kbit/s
- Maximum 47677 Kbit/s

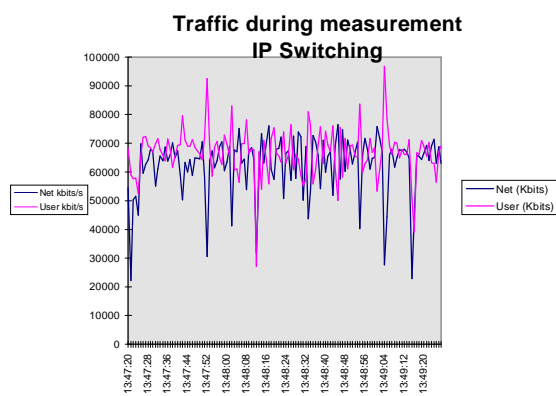

- Mean 62484 Kbit/s
- Minimum 22172 Kbit/s
- Maximum 76488 Kbit/s



IPS - 2 processes

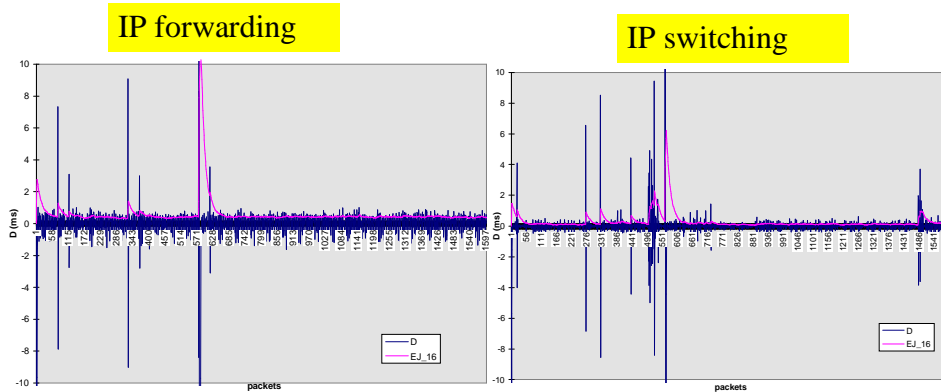
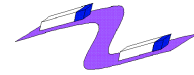

ip switching TCP/IP load (2) summary

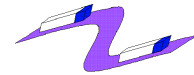

Differences in packet spacings of voice stream:

- IP Forwarding
 - Standard Deviation 2,68
 - Sample Variance 7,19
 - Minimum -19,77
 - Maximum 105,45
- IP Switching
 - Standard Deviation 2,22
 - Sample Variance 4,94
 - Minimum -19,32
 - Maximum 108,34



ip switching TCP/IP load (8) ... packet spacings

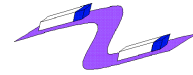

- Load with a client-server application:
 - perl scripts run on edge routers
 - sends 1500 byte TCP/IP packets
 - 2 x 4 sending processes

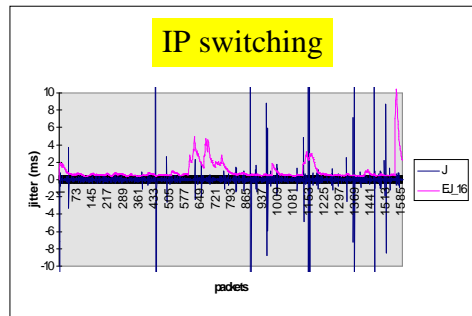
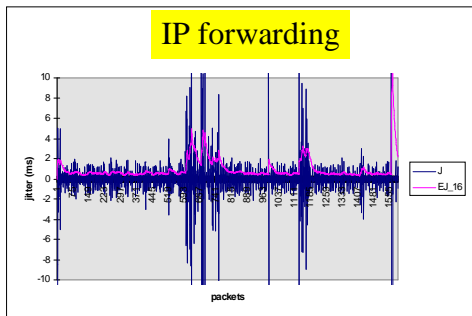

ip switching TCP/IP load (8) ... frequencies

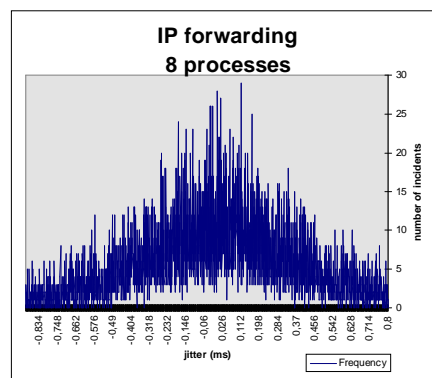
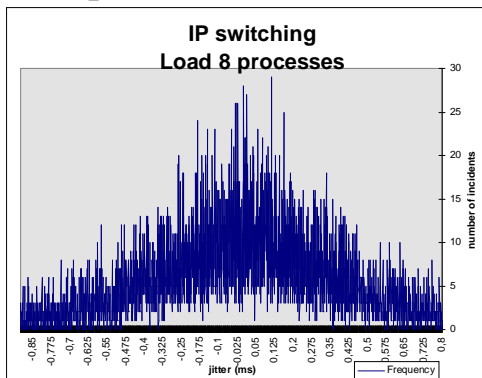
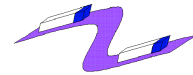

IP switching

- Standard Deviation 2,00
- Sample Variance 4,01
- Minimum -19,77
- Maximum 108,63

IP forwarding

- Standard Deviation 2,63
- Sample Variance 6,92
- Minimum -19,76
- Maximum 108,63



IPS - mixed load

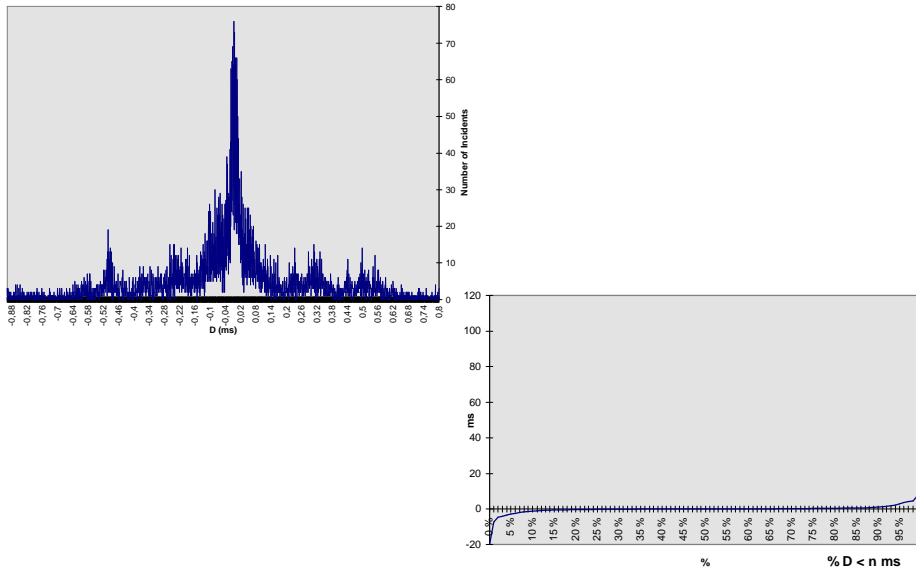
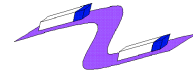

IP Switching mixed load ...gettin' that last byte



Differences in packet spacings of voice stream:

- Standard Deviation 2,93
- Sample Variance 8,56
- Minimum -19,77
- Maximum 101,78

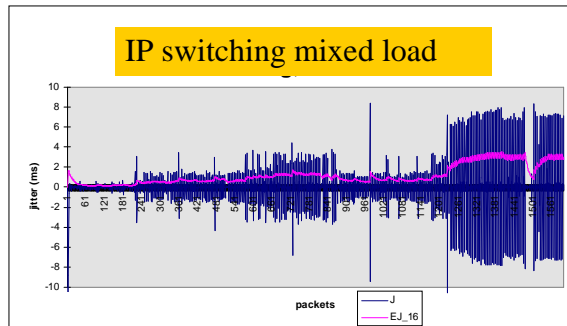



IP-puhe IP-kytketyssä verkossa

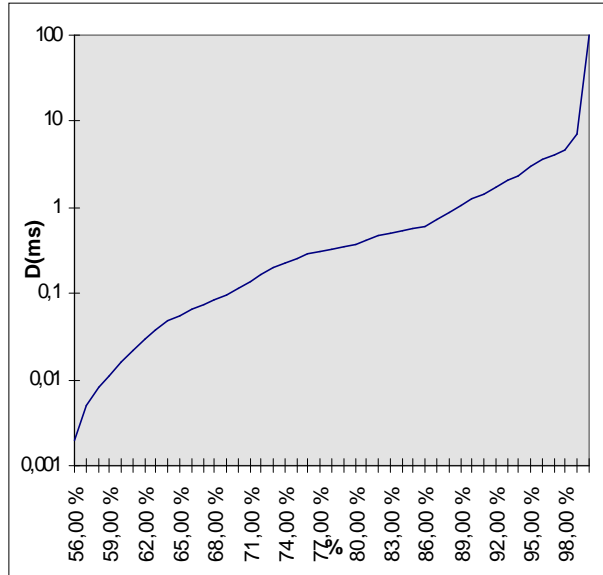
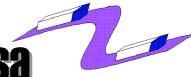

Estimaattien virheet

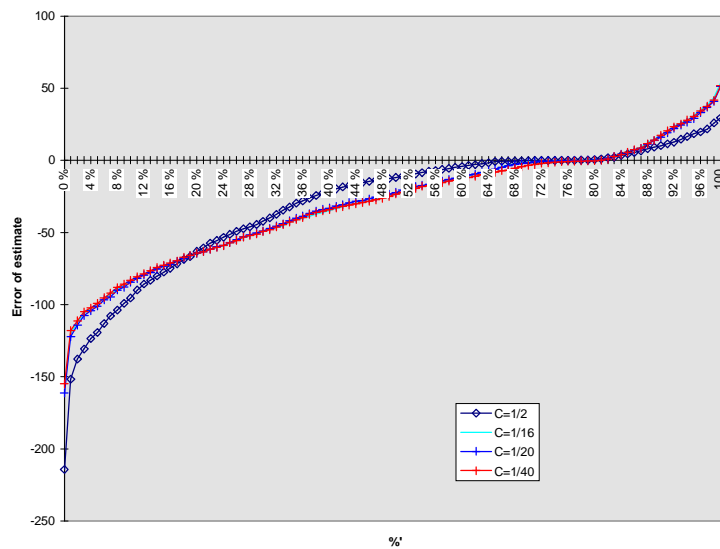



Conclusions

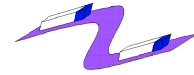

- End-to-end delays caused by poor terminal performance
=> functions on hw
- At its best delays acceptable, around 100ms (GSM 80ms)
- IP switching reduces network caused jitter of audio stream
 - when most traffic switched
 - proritizing increases differences
 - no differences in fixed delay (network too small)
- IP switching increases throughput of network
 - compared to IP forwarding... but not to wire-speeds yet
- Even with worst loads all measured networks good for VoIP
- Even the generic interarrival jitter estimation algorithm ok, although the weighting factor in RTP not optimal => adaptive algorithms with error feedback



Voice over IP Measurements

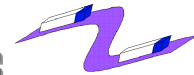

- Contents:
 - Concepts: delay, delay variance (jitter), synchronization
 - Measurement setup
 - End-to-end delay measurements
 - Delay variance of a voice stream over Ethernet
 - Delay variance of a voice stream over IP switching
 - Conclusions